

Single Emitter Diode Laser (CW)

COC11



Features

- AuSn bonding
- Copper-clad plate design
- Harsh environment use

Applications

- Pumping
- Medical
- Industry
- Illumination
- Scientific research

Product Dimensions (mm)

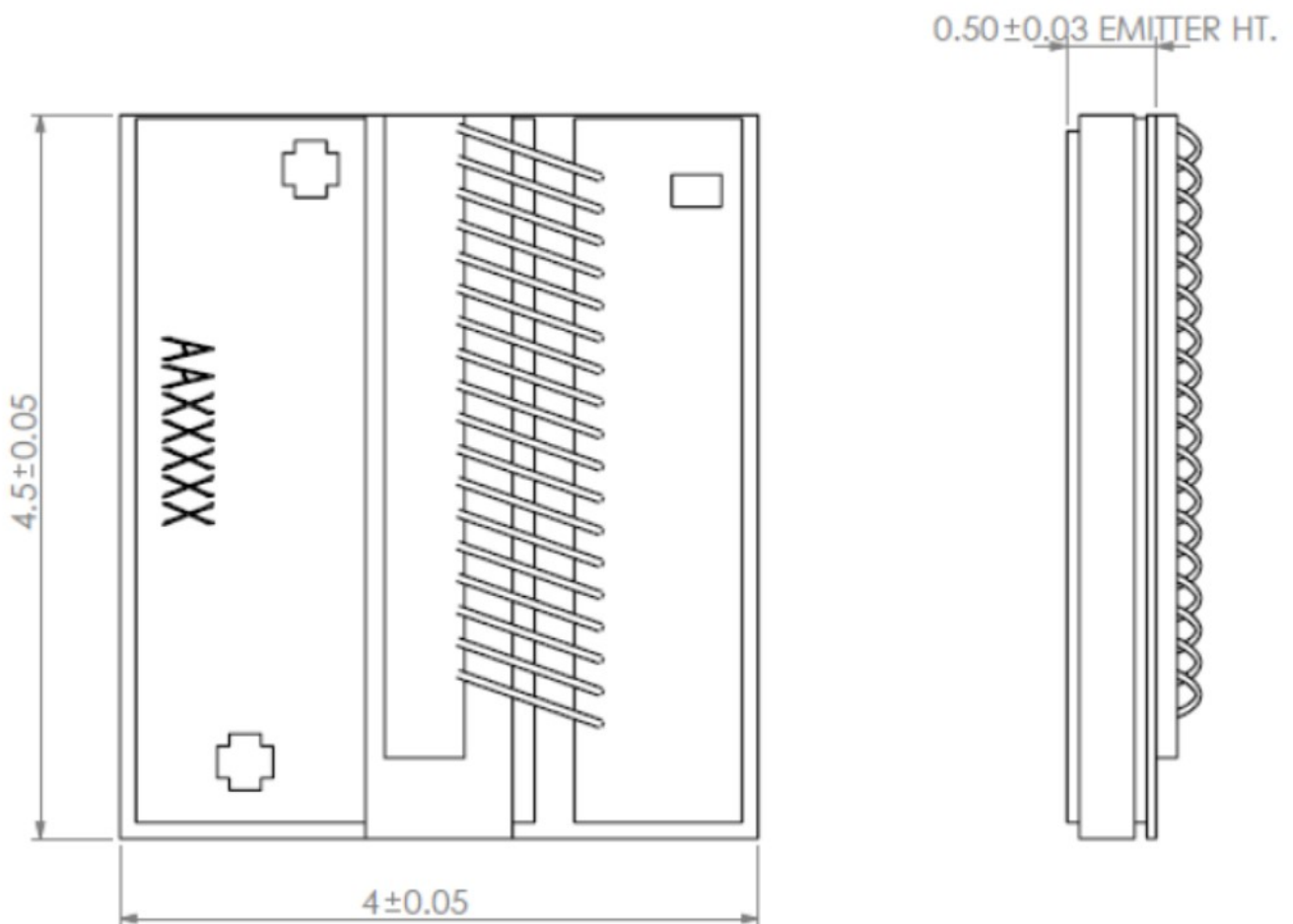

Remark: The structure drawing is for reference only. Please feel free to contact us for any special requirements.

Product Specifications

Product Code	OPD000082	OPD000084	OPD000009	OPD000010
Part No. ¹	FL-COC11-10-808	FL-COC11-12-915	FL-COC11-12-940	FL-COC11-12-976

Optical Data ²	Unit	Value			
Centroid Wavelength	nm	808	915	940	976
Wavelength Tolerance	nm	± 3	± 10	± 5	± 5
Emitter Width	µm	200	100	100	100
Output Power ³	W	10	12	12	12
Spectral Width FWHM	nm	≤ 3	≤ 4.2	≤ 4.5	≤ 4.5
Spectral Width 90% Energy	nm	≤ 5	≤ 6	≤ 7	≤ 7
Fast Axis Divergence (FWHM)	°	~ 30	~ 30	~ 30	~ 30
Slow Axis Divergence (FWHM)	°	8	8	8	8
Polarization Mode	-	TE	TE	TE	TE
Wavelength Temp. Coefficient	nm / °C	~ 0.28	~ 0.32	~ 0.33	~ 0.34

Electrical Data ²					
Operation Current	A	≤ 11.8	≤ 13	≤ 13	≤ 13
Threshold Current	A	≤ 1.8	≤ 0.8	≤ 0.8	≤ 0.8
Operating Voltage	V	≤ 2.2	≤ 2	≤ 2	≤ 2
Slope Efficiency	W / A	≥ 1	≥ 1	≥ 1	≥ 1
Power Conversion Efficiency	%	≥ 44	≥ 50	≥ 50	≥ 50

Thermal Data					
Operating Temperature	°C	15 ~ 30	15 ~ 30	15 ~ 30	15 ~ 30
Storage Temperature ⁴	°C	-40 ~ 55	-40 ~ 55	-40 ~ 55	-40 ~ 55
Recommended Heatsink Capacity	W	≥ 20	≥ 24	≥ 24	≥ 24

¹Part No. = Brand Code - Series - Power - Centroid Wavelength (- Collimation).

²Data at 25°C temperature, unless otherwise stated.

³Lifetime reduced if overused under nominal operating condition.

⁴A non-condensing environment is required for storage and operation below ambient dew point.

